



PAKISTAN NATIONAL SHIPPING CORPORATION

(Statutory Corporation, Established under the ordinance, XX of 1979)

URGENT REQUIREMENT, AS PER PPR RULE 42, (d)(iii)

NEGOTIATED TENDER FOR REPLACEMENT OF 03 NOS. FCU UNITS (04 TONS)
INSTALLED AT GROUND FLOOR PNSC BUILDING (HBL BRANCH)

APRIL 2026

Engr. Muhammad Hassan
Manager (Work & Services)

**NEGOTIATED TENDER FOR REPLACEMENT OF 03 NOS. FCU UNITS (04 TONS) INSTALLED AT
GROUND FLOOR PNSC BUILDING (HBL BRANCH)**

BID FORM

URGENT REQUIREMENT, AS PER PPR RULE 42, (d)(iii) & APPROVED PNSC PROCUREMENT POLICY 4.14.3.3

BID NO. PRCD/FCU-UNIT/PNSC-HBL/2026/009

BID CLOSING DATE/TIME : MAY 7TH, 2026 BY 11:00 A.M

BID OPENING DATE/TIME : MAY 7TH, 2026 BY 11:30 A.M

PNSC invites quotation under Rule 42(d)(iii) for negotiated tendering for the **Replacement of 03 Nos. FCU Units (04 Tons) Installed at Ground Floor PNSC Building (HBL Branch).**

SR. #	SPECIFICATION	QTY	Unit Price (with Tax)	Total Amount (With all Taxes)
1	<p><u>4 TON FAN COIL UNIT (CHILLED WATER)</u> Model: ZS-FCU-4T Capacity: 4 Ton, (Approx, 48,000 BTU/HR) Airflow: 2000 CFM Approx, Entering Water Tamp: 7C Leaving Water Tamp: 12C Water Flow Rate: 16.5 LPM (Approx.) Coil: Copper Tube/Aluminum Fins, Blower Type: Centrifugal (Double Inlet), Motor: 3 Speed 230V/50Hz/1 PH Voltage: 220/380/415V Connection: 1" BSP (Female) Filter: Washable</p> <p>• <i>(Complete Dismantling, Installation, Configuration and Commissioning must be performed by the successful bidder at Ground Floor PNSC Building (HBL Branch)</i></p>	03		
TOTAL AMOUNT OF PKR: (INCLUDING ALL TAXES)				

QUALIFICATION CRITERIA REQUIRED FROM BIDDERS AS FOLLOWS:

- Bidder must be registered with Tax Authorities as per prevailing latest tax rules and should have valid National Tax Number (N.T.N) and General Sales Tax (G.S.T) & should be enrolled/enlisted on Active Taxpayers List (A.T.L) of FBR. (Valid Copies are attached)
- Bidder to submit Affidavit of undertaking that firm(s) or it's affiliated/concerns are not blacklisted by PPRA/ Government Ministries / Department or Public Sector entities would be eligible to participate in the bid.
- Bidder must have at least 01 year of experience and have minimum 02 similar types of sales (Copy of POs/Invoices to be attached).
- Purchase Order will be awarded to the Most Advantageous bidder.
- Successful bidders shall submit a performance guarantee equal to Five percent (05%) of the contract amount, which shall be refunded thirty (30) days after the satisfactory delivery & Successfully Installation, Configuration and Commissioning of the awarded items.
- **Delivery & Installation Time:** Within Two (02) weeks after the issuance of the Purchase Order.
- The Bid Validity period shall be **30 Days**.
- Installation, Configuration and Commissioning must be performed by the successful bidder
- Prices should be inclusive of all taxes. Used/Refurbished items shall not be accepted.
- The successful bidder shall affix the Stamp Duty of (@0.25 Twenty Five Paise) for every Hundred Rupees of Total Contract Amount.
- In case of discrepancy between unit price and total, the unit price shall prevail.

ENGR. MUHAMMAD HASSAN | MANAGER (MAINTENANCE & PROJECT)

MAINTENANCE & PROJECT/TECHNICAL DEPARTMENT,
12TH FLOOR, PNSC BUILDING, MT KHAN ROAD, KARACHI.

PHONE: 92-21-99203980 TO 99 (EXT. 3030)

EMAIL: muhammad.hassan@pns.com.pk

WEBSITE: WWW.PNSC.COM.PK

*Engr. Muhammad Hassan
Manager (Work & Services)*



**NEGOTIATED TENDER FOR REPLACEMENT OF 03 NOS. FCU UNITS (04 TONS) INSTALLED AT
GROUND FLOOR PNSC BUILDING (HBL BRANCH)**

COMPLETE SCOPE OF WORK

Supply, Dismantling, Testing & Commissioning of 4 TR FCU Unit installed at PNSC Ground Floor, (HBL Branch).
Diagram enclosed

- a. **Dismantling**
- Existing FCU dismantling,
 - Lowering to Ground,
 - Disconnect Piping & Ducting,
 - Site Cleaning,
- b. **SUPPLY OF NEW FCU**
- 4 TR FCU,
 - Double Skin Body,
 - High Efficiency Coil,
 - Imported Motor,
- c. **INSTALLATION**
- Lifting & Shifting,
 - Hanging with Support,
 - Alignment ,
- d. **PIPING WORK**
- Supply & Return Piping Connection,
 - Leak Testing,
 - Installation,
- e. **DUCTING WORK**
- Supply & Return Duct Connection,
 - Gap Ducting
 - Sealing,

Engr. Muhammad Hassan
Manager (Work & Services)



CONTRACT FORMS

THIS CONTRACT is made and entered into at Karachi on the _____ Day of _____ 2026,

– BY & BETWEEN –

PAKISTAN NATIONAL SHIPPING CORPORATION (PNSC) is a Statutory Corporation established under the Pakistan National Shipping Corporation **Ordinance No. XX of 1979**, having its Head Office at PNSC Building, Moulvi Tamizuddin Khan Road, Karachi Pakistan (hereinafter referred to as the "Corporation" which expression wherever the context so permits shall include the legal representatives and assigns), party of the **ONE PART**.

– AND –

M/S _____, a company duly organized and existing under the law of **Islamic Republic of Pakistan** having its registered office at _____ (hereinafter referred to as "Supplier/Contractor" which terms wherever it occurs in these presents shall mean and include its successors-in-interest executors and permitted assigns); Party of the **SECOND PART**.

(The "Corporation" and the "Supplier/Contractor" hereinafter referred to individually as "**Party**" and collectively as the "**Parties**")

NOW THIS CONTRACT WITNESSETH AS FOLLOWS

1. In this Contract words and expressions shall have the same meanings as are respectively assigned to them in the Conditions of Contract referred to.
2. The following documents shall be deemed to form and be read and construed as part of this Contract, In the event of any ambiguity or conflict between the Contract Documents listed below, the order of precedence shall be the order in which the Contract Documents are listed below:-
 - (a) This form of Contract;
 - (b) the Form of Bid and the Price Schedule submitted by the Bidder;
 - (c) Complete Scope of Work,
 - (d) the Procuring Agency's Letter of Acceptance; and
3. In consideration of the payments to be made by the Procuring Agency to the Supplier as hereinafter mentioned, the Supplier hereby covenants with the Procuring Agency to provide the goods and related services and to remedy defects therein in conformity in all respects with the provisions of the Contract.
4. The Procuring Agency hereby covenants to pay the Supplier in consideration of the provision of the goods and related services and the remedying of defects therein, the Contract Price or such other sum as may become payable under the provisions of the contract at the times and in the manner prescribed by the contract.
5. The successful bidder shall affix the contract form and terms & conditions on Non-Judicial Paper of Rs. 100/- and Stamp Duty of (@0.25 Twenty Five Paisa) for every Hundred Rupees of Total Contract Amount.

"IN WITNESSETH WHEREOF, the parties hereto have signed this Contract and has caused the common seal to be affixed on the Contract in the manner hereinafter appearing on the day and year first here-in-above written."

For and Behalf of Pakistan National Shipping Corporation
(One Part):

For and Behalf of Contractor/Service Provider _____
(Other Part):

Signature: _____

Signature: _____

Name: _____

Name: _____

Designation: _____

Designation: _____

Address: _____

Address: _____

Telephone No: _____

Telephone No: _____

WITNESSES:

1. _____

2. _____

Engr. Muhammad Hassan
Manager (Work & Services)



4 TON FAN COIL UNIT (CHILLED WATER)

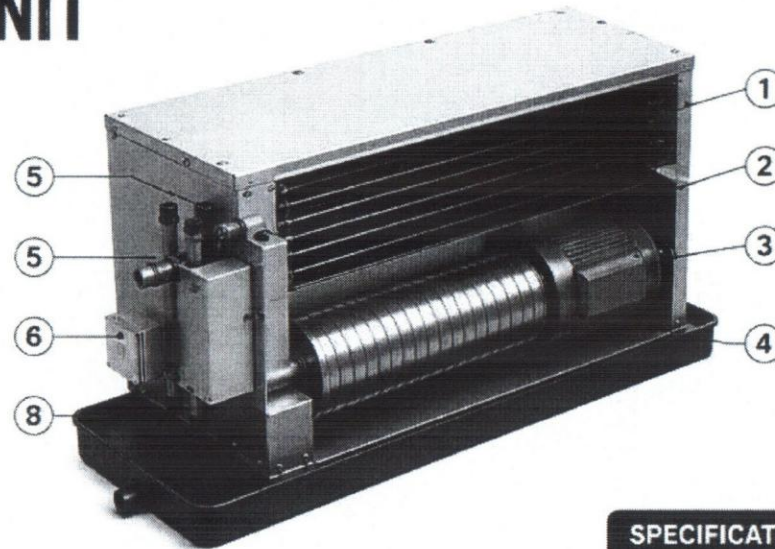
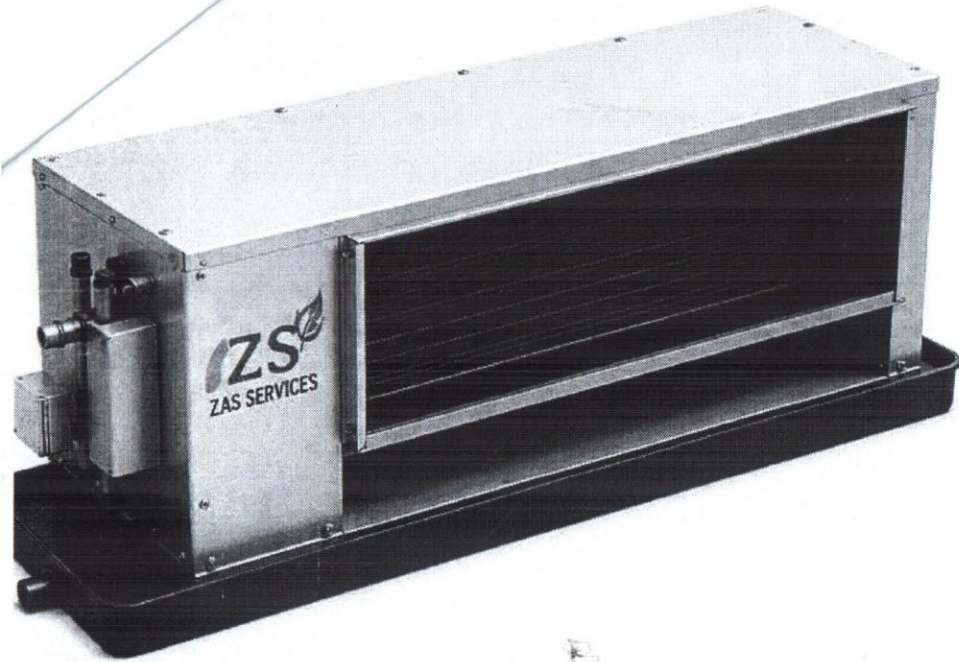

COMPONENTS

- 1 Chilled Water Coil
- 2 Centrifugal Blower
- 3 Electric Motor
- 4 Drain Pan
- 5 Air Vent
- 6 Water Inlet
- 7 Water Outlet
- 8 Electrical Box

SPECIFICATIONS

Model	: ZS-FCU-4T
Capacity	: 4 Ton (Approx. 48,000 BTU/Hr)
Air Flow	: 2000 CFM (Approx.)
Entering Water Temp.	: 7 °C
Leaving Water Temp.	: 12 °C
Water Flow Rate	: 16.5 LPM (Approx.)
Coil	: Copper Tube with Aluminium Fins
Blower Type	: Centrifugal (Double Inlet)
Motor	: 3 Speed, 230V / 50Hz / 1Ph
Drain Connection	: Ø 25 mm (1")
Connections	: 1" BSP (Female)
Unit Weight	: 130 - 150 kg (Approx.)

DIMENSIONS (mm)

FRONT VIEW

1350

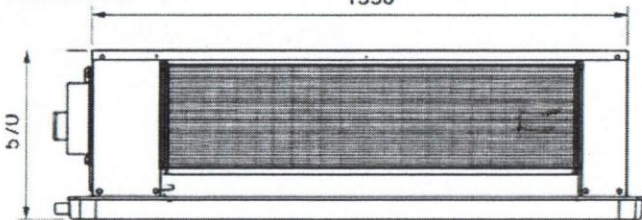

TOP VIEW

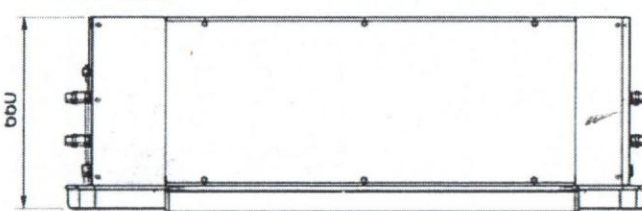

SIDE VIEW

660

570

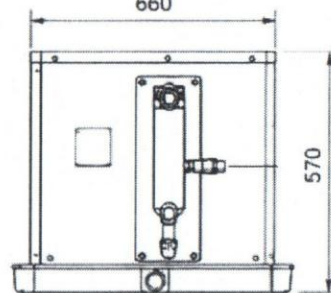

ISOMETRIC VIEW

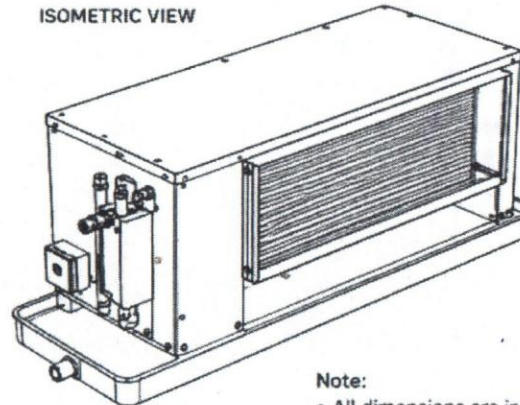

Note:

- All dimensions are in mm.
- Specifications are subject to change without prior notice.

CONNECTION DETAIL

